

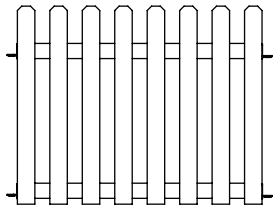

Cedar No Dig Fencing System

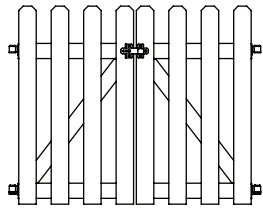

Panels
Model #820415



Gate
Model #820439

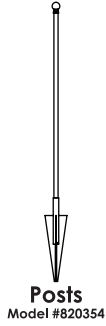

Posts
Model #820354

No Dig Fencing System - Install

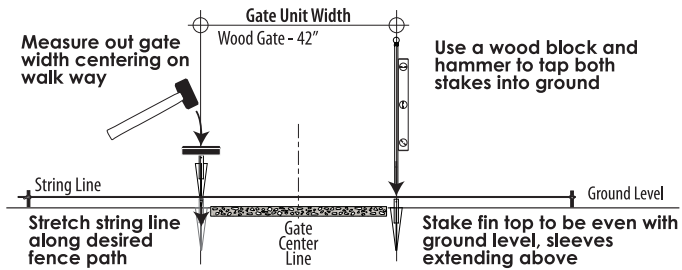

Panel ring rests on top of stake sleeve
Bottom gate hinge rests on top of base panel ring

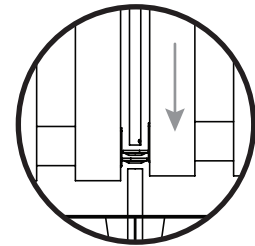
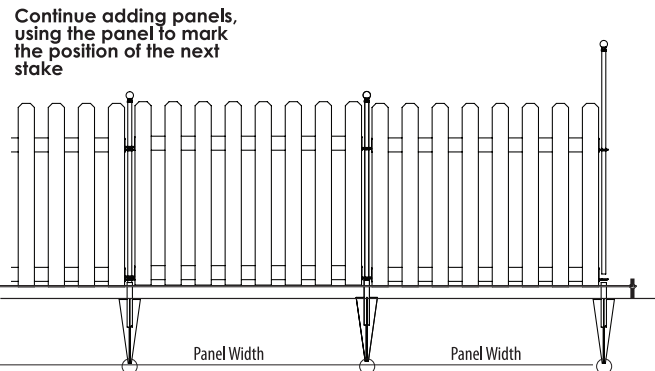
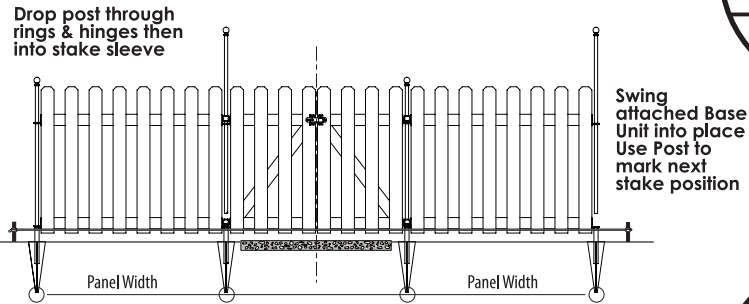
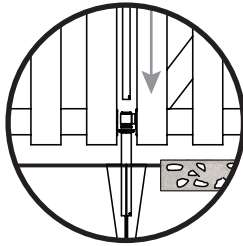

Left panel (lower) rings rest on top of stake sleeve
Right panel (raised) rings rest on top of left panel rings
Push post through all rings and into stake sleeve

No Dig Fencing System - Gate Latch Installation

Drill pilot 1/16" holes in positions shown and attach latch to wood picket with Phillips screws.

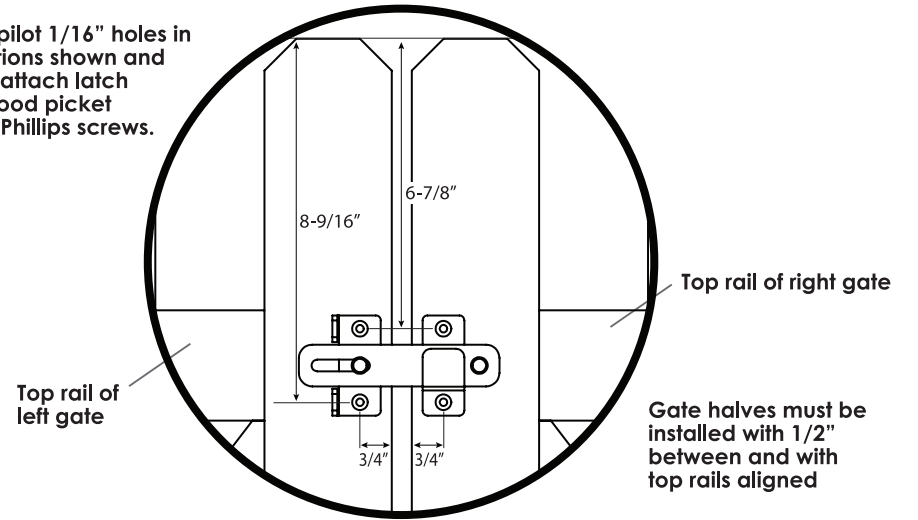

No Dig Fencing System - Gate Adjustment

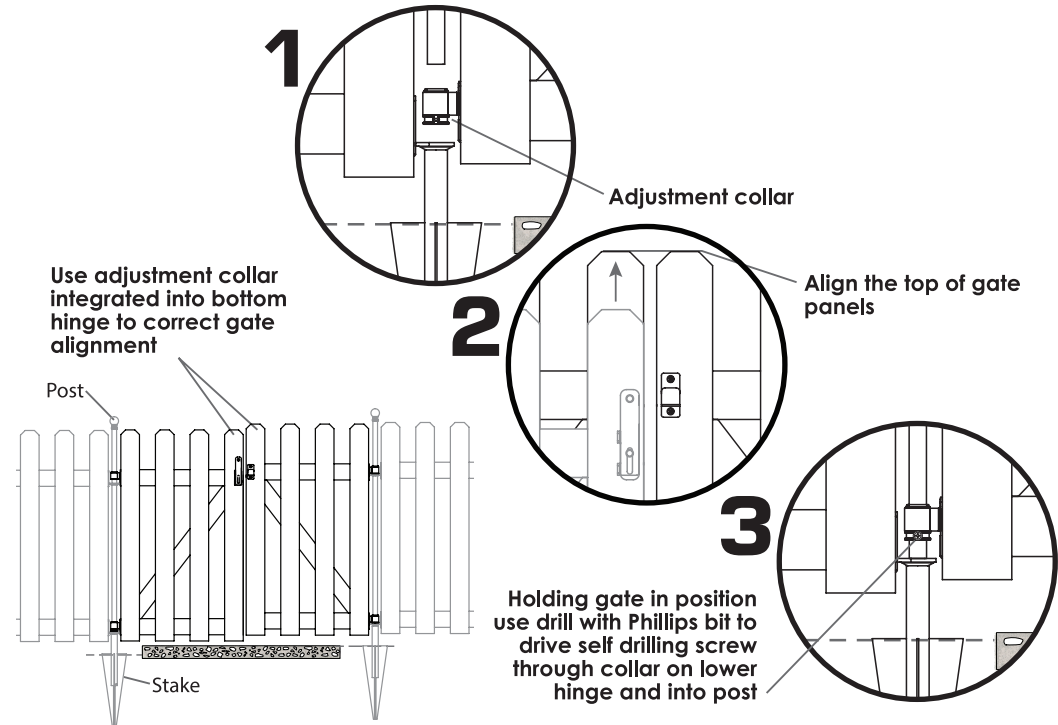

Questions, problems, missing parts? Before returning to your retailer, call our customer service department at 800.607.6409, 8:00 am - 5:00 pm EST Monday - Friday. Or eMail us at CustomerService@OPBglobal.com